

7" x 2" x 1/4"
Angle Bracket

5" x 2" x 1/8"
Angle Bracket

3" x 1" x 1/8"
Channel

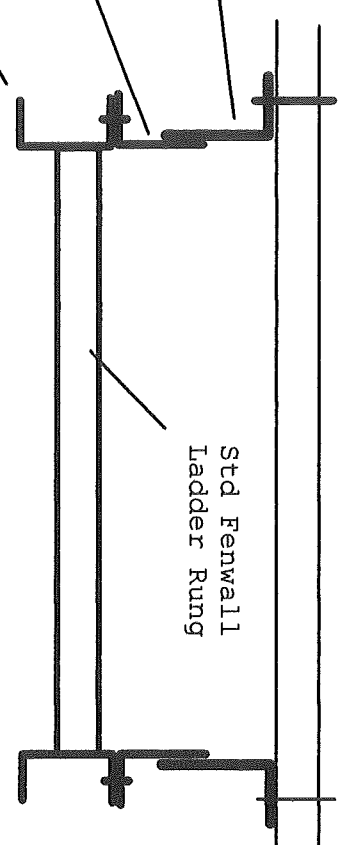

Fenwall, LLC.
13046 Racetrack Rd, Suite 177 Tampa, FL 33626
813 925-0144 813 925-1414 fax

Standard Ladder	
Mill Finish Aluminum	
STDLAD	NTS

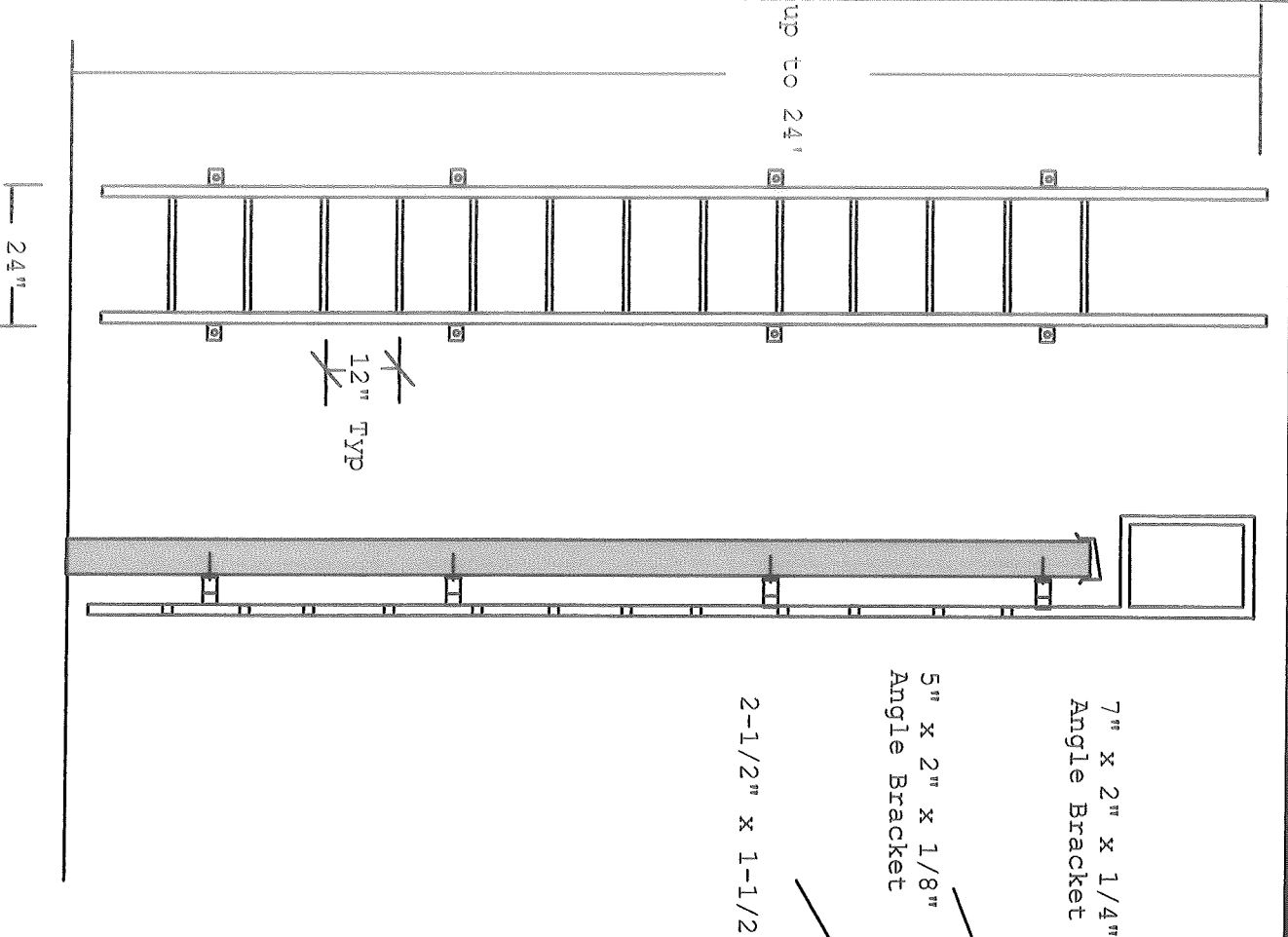

7" x 2" x 1/4"
Angle Bracket

5" x 2" x 1/8"
Angle Bracket

2-1/2" x 1-1/2" x 1/8" Channel

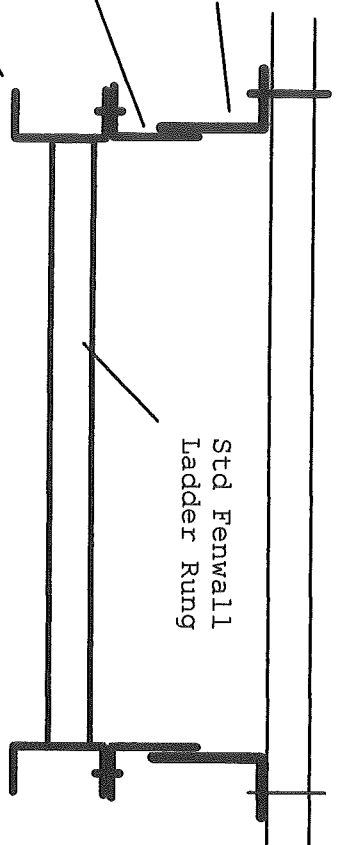

Std Fenwall
Ladder Rung

Fenwall, LLC.
13046 Racetrack Rd, Suite 177 Tampa, FL 33626
813 925-0144 813 925-1414 fax

Standard Ladder With Grab Loop.

Mill Finish Aluminum

Loop

NTS

up to 24'

24"

96"

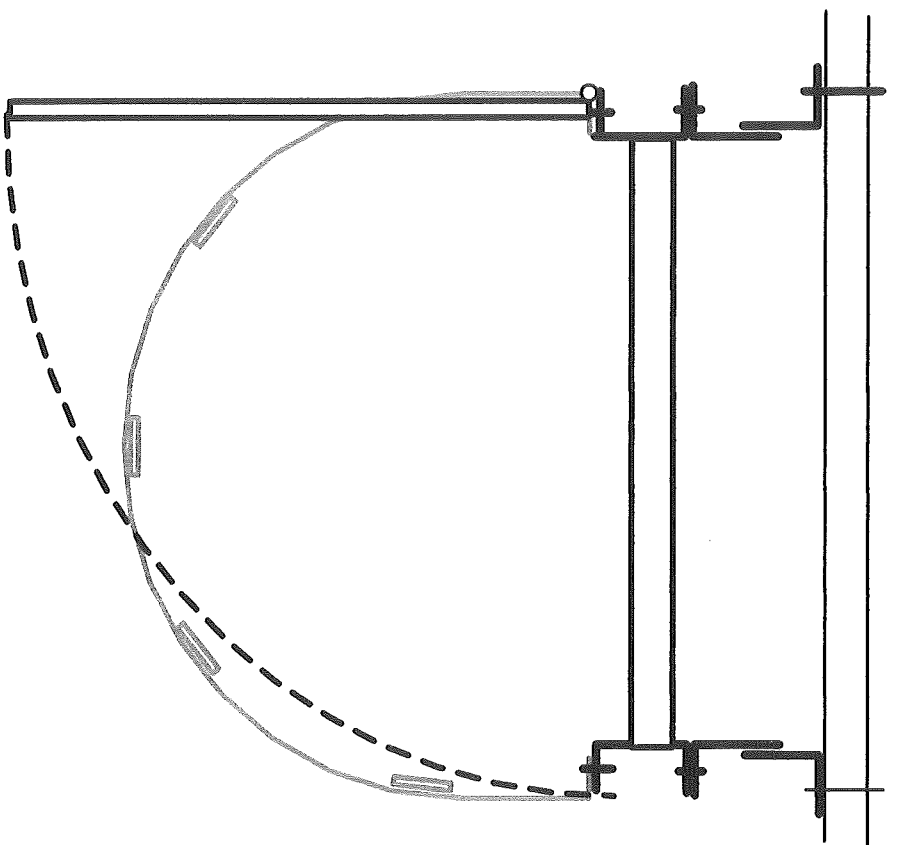

Fenwall, LLC.
 13046 Racetrack Rd, Suite 177 Tampa, FL 33626
 813 925-0144 813 925-1414 fax

Standard Ladder with Security Door

Mill Finish Aluminum

SECDOOR

NTS

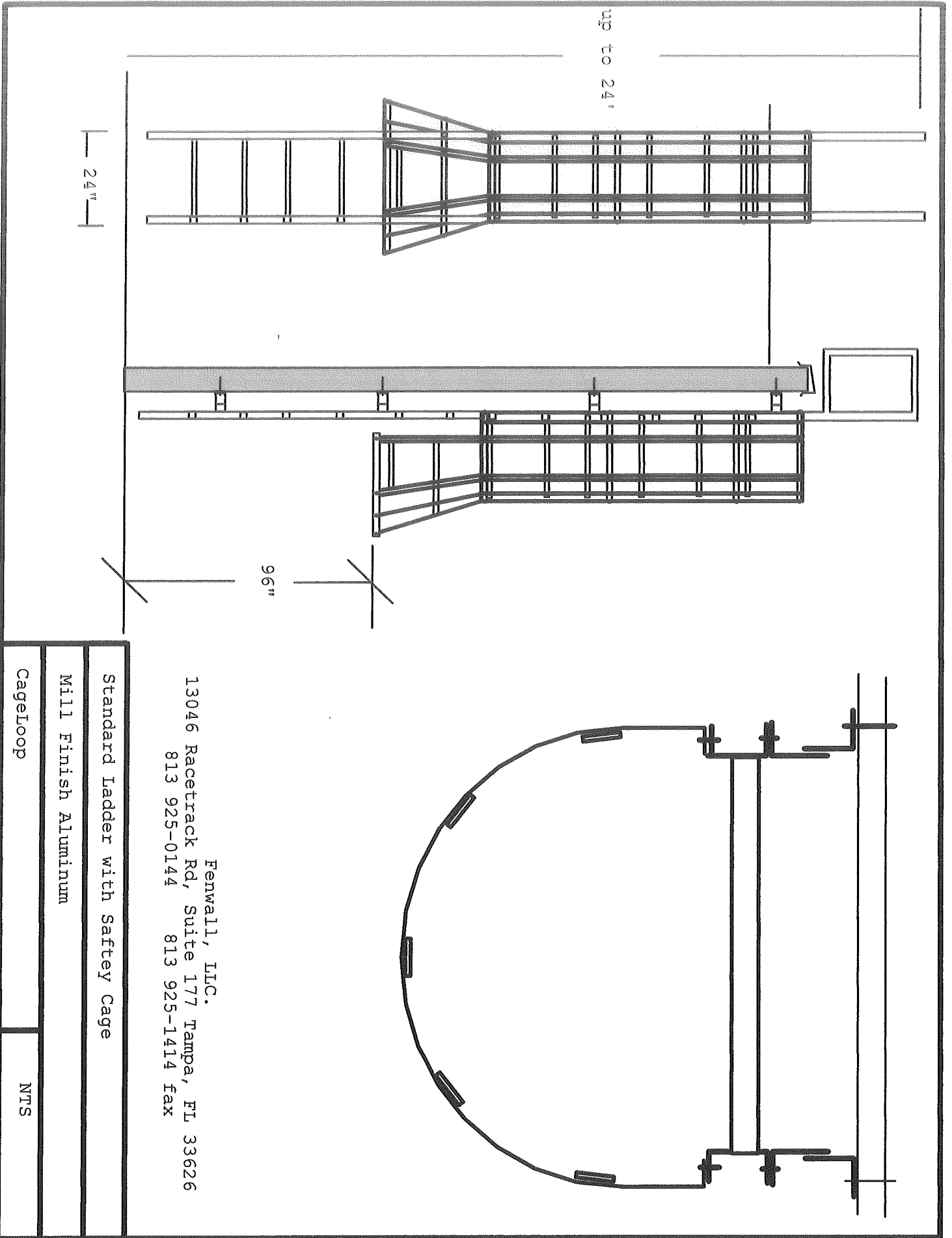

Fenwall, LLC.
 13046 Racetrack Rd, Suite 177 Tampa, FL 33626
 813 925-0144 813 925-1414 fax

Standard Ladder with Safety Cage

Mill Finish Aluminum

CageLoop

NTS

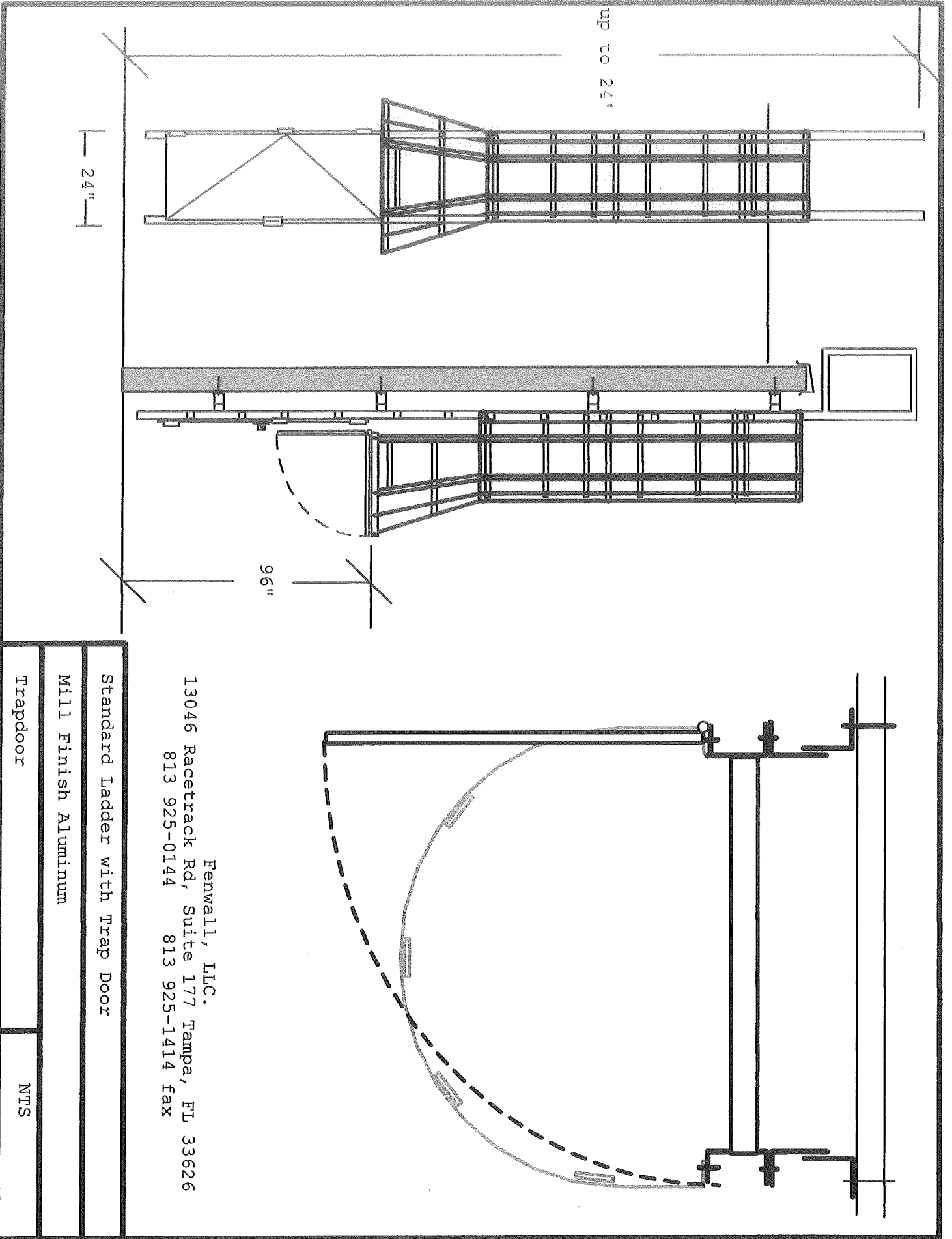

Fenwall, LLC.
 13046 Racetrack Rd, Suite 177 Tampa, FL 33626
 813 925-0144 813 925-1414 fax

Standard Ladder with Trap Door

Mill Finish Aluminum

Trapdoor

NTS

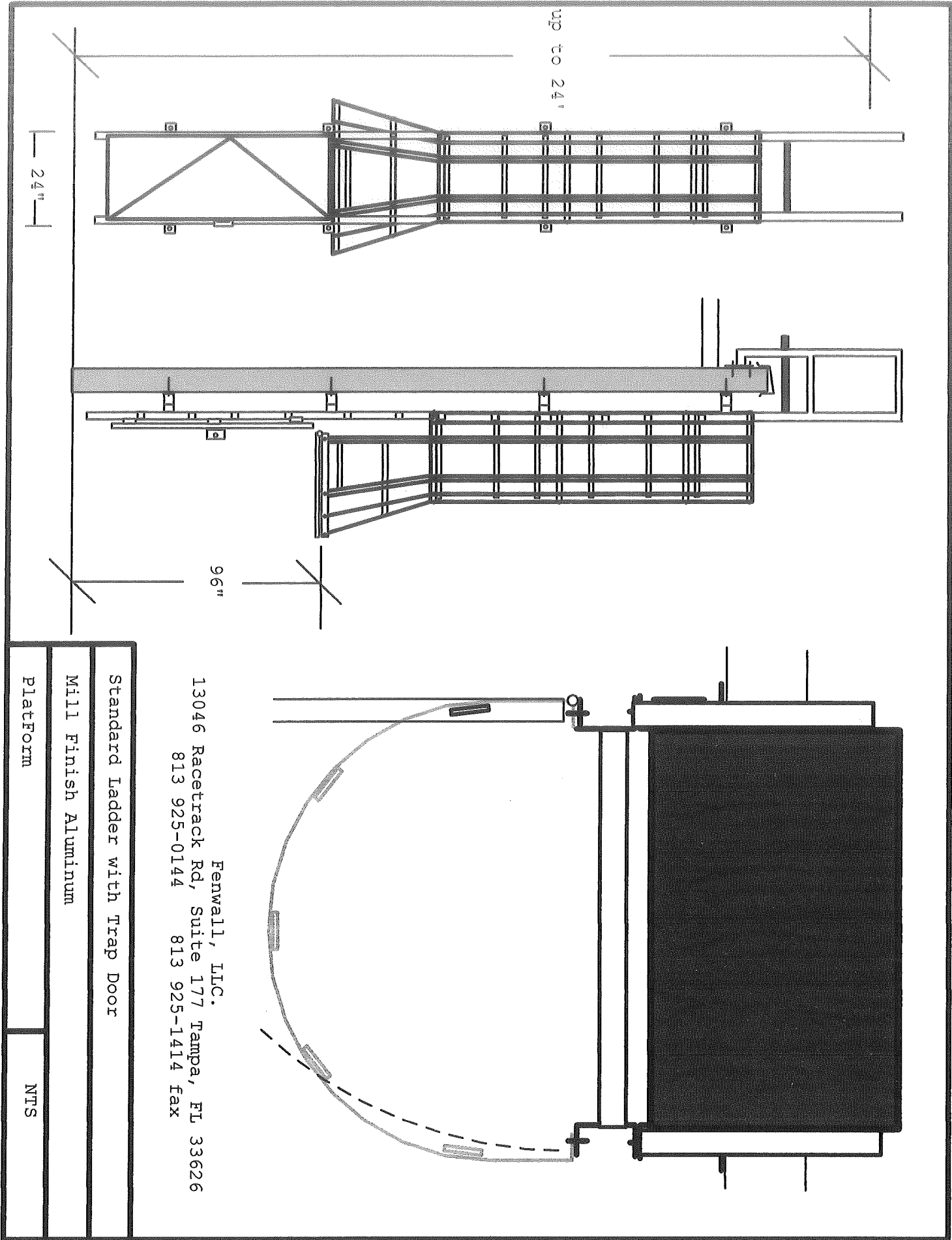

Fenwall, LLC.
 13046 Racetrack Rd, Suite 177 Tampa, FL 33626
 813 925-0144 813 925-1414 fax

Standard Ladder with Trap Door

Mill Finish Aluminum

Platform

NTS